

Every drop makes a difference

Triton Shower Range

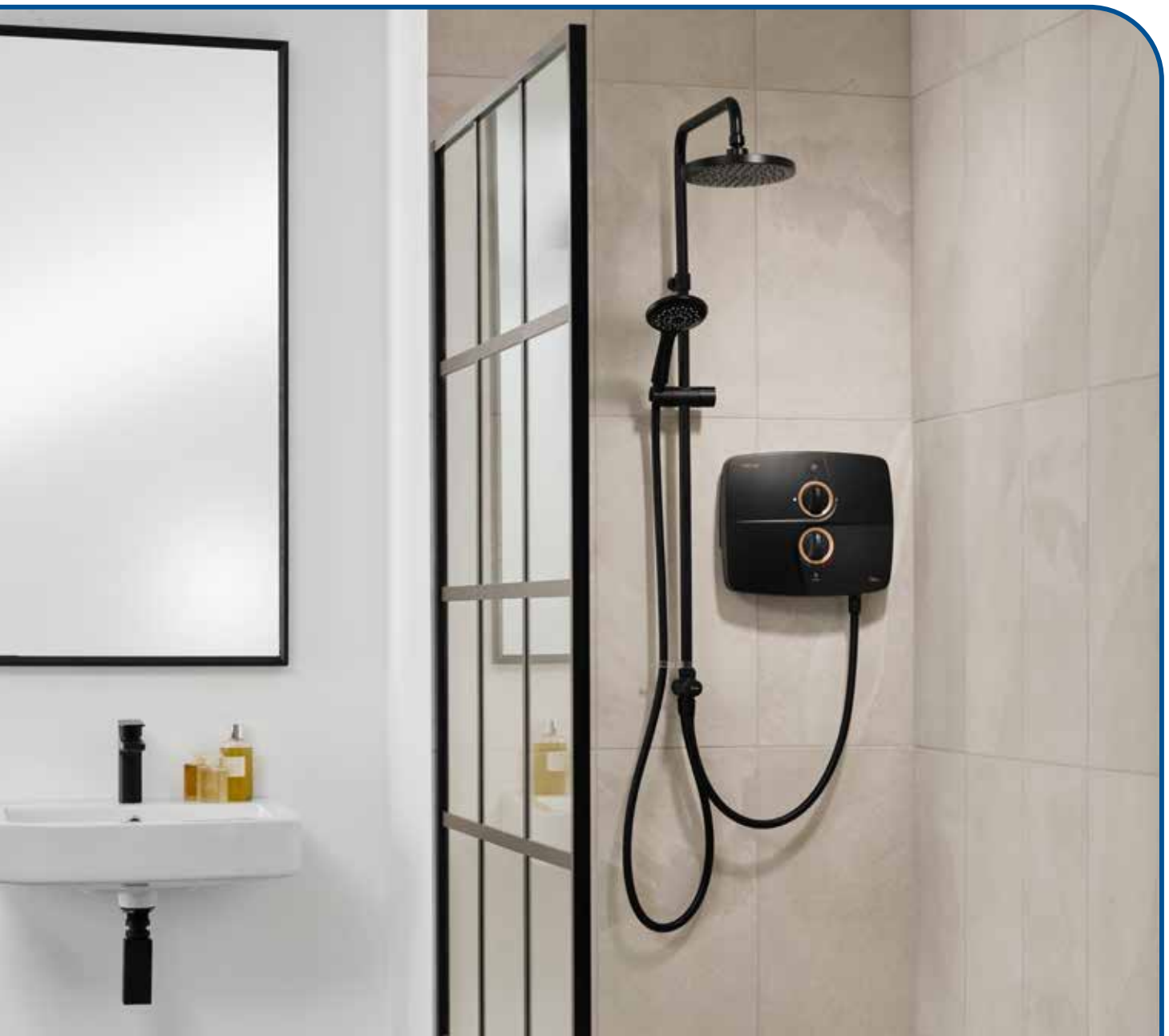

Design, function and reliability

At Triton, we make showers. That's nothing world-changing, but we're trying to do our bit. An electric shower will help save water, save energy and save you money. Meaning households in Ireland can enjoy every wash with a cleaner conscience.

We're proud to be known as 'The Great Irish Shower company,' having produced expertly engineered, innovative shower designs since 1975. We have been at the forefront of providing customers with energy-efficient showering for over 45 years.

Our showers are expertly designed and rigorously tested. That way, we've done absolutely everything we can to provide a reliable, enjoyable product that works perfectly every time.

With rising living costs and increasing demand for natural resources, every drop really does make a difference when selecting energy-efficient water heating appliances for the home.



Reasons to choose Triton



Full Parts and Labour Guaranteed

Full parts & labour guarantee on every shower we make.



Fit and Forget

Buy it, fit it and forget it – because our superb service team is always on tap.



Easy to Install

Our showers are designed with quick, hassle-free fitting in mind.



Trusted Triton Service

Trust our national team of shower experts to keep your shower running day or night.



For a Cleaner Conscience

Electric showers are an efficient and more sustainable way to heat and use water.

Connect with us at tritonshowers.ie



Contents

Design, Function & Reliability	2 – 3
The Triton Shower Range Explained	4 – 5
Mixer Showers	6 – 15
Digital Showers	16 – 21
Electric Showers	22 – 31
Pumped Electric Showers	32 – 37
Care Showers	38 – 45
Shower Accessories	46 – 47
Power Showers	48 – 49
Handwash & Water Heaters	50 – 57
Help Me Choose	58 – 59
Euro Standards	60 – 61
Shower Specifications	62 – 67

The Triton shower range explained

Electric Showers

Energy efficient electric showers draw on the cold mains water supply and instantly heat water on demand meaning every drop really does make a difference. Save water, save energy and save money.

Thermostatic Electric Showers

Thermostatic electric showers work in the same way as an electric shower, with the added benefit of thermostatic temperature control. They regulate the water temperature to your personal needs, regardless of other water usage in the household.

Pumped Electric Showers

Pumped electric showers heat the water on demand and have a built in pump to boost water flow, overcoming low or unreliable water pressures.

Care Showers

Inclusive showers have been specifically designed to combine everyday good looks with easy to use features, aiding independent living. A selection of products are RNIB, BEAB CARE or Type 3 endorsed for extra safety assurance, be it for care, nursing homes or a stylish at-home adapted bathroom.

Mixer Showers

Mixer showers draw from both hot and cold water supplies which are readily available via a combi boiler or large capacity hot water cylinder. The water is then mixed within the valve.

Eco Showers

Eco Showers have been designed to offer 50% reduction in water usage when compared to conventional showers. Ideal for new-build or self-build projects.

Power Showers

Power showers have an integrated pump to boost flow rate. They draw from both hot and cold water supplies which are mixed within the unit, and are only suitable for low pressure systems.

Digital Mixer Showers

Triton digital mixer showers offer an unbeatable combination of smart state of the art technology, stylish choices and ease of installation with total control over your showering experience.

Shower Accessories

Triton offers a wide range of showering accessories including shower heads, kits, bar brackets as well as hoses and rails. As you would expect all are tested thoroughly to work perfectly with our range of showers and in the UK market. Always fit Triton accessories to safely get the best out of your shower for longer.

For electric showers, all kW's quoted are rated at 240V unless specified otherwise.

Choose the solution you require and then look for the relevant colour or symbol to find the right Triton shower for you...

Shower symbols explained

Look for the following symbols on our showers:



Our showers are all guaranteed for 2 years full parts and labour for domestic use.



Showers which are suitable for Low pressure systems.



Our showers are all guaranteed for 5 years full parts and labour for domestic use.



Showers which are suitable for Low pressure systems when used with a pump.



Showers which are suitable for both High and Low pressure systems.



Showers which are suitable for cold mains systems.



Showers which are suitable for High pressure systems.



The shower is operated by a discreet control panel which is located away from the power pack. The power pack can be hidden in a loft or airing cupboard.



Thermostatic temperature explained

(Available for mixer, electric, digital and power showers)

You'll notice some of our showers are described as Thermostatic. Thermostatic showers blend incoming water to compensate for variations in the pressure and/or temperature to maintain a selected temperature. This allows you more control over your showering experience, which is ideal for busy households, particularly those with children or elderly users.

Accreditations



BEAB CARE - British Electrotechnical Approvals Board Accreditation.



A recognised Safety Mark used to support CE Marking & demonstrates conformity with the Low Voltage Directive (LVD)



RNIB - Royal National Institute of Blind People Accreditation.



All electric showers comply with BEAB, CE and BSI Kitemark approvals.



TMV2 is an accreditation for thermostatic mixing valves that conform to BS-EN 1111 and BS EN 1287.



Type 3 is a standard created for thermostatic mixing valves that comply with NHS Estates requirements.



WRAS - The Water Regulations Advisory Scheme accreditation.



Suitable for hard water areas, helping to reduce scale build up.



BMA Unified Water Efficiency 'Recommended' Product Label applicable for electric showers



Quiet Mark technically assesses and certifies the quietest solutions to unwanted noise

Mixer Showers

Triton mixers offer a wide choice of styles and functions. Expertly designed and lifetime tested for durability and performance.

From modern contemporary bar diverters to inclusive design for care applications, there are plenty of styles to choose from that offer unbeatable quality and great value.



Thermostatic Mixer Shower

The Push Button Diverter Range

This contemporary bar diverter mixer shower features a push button to make switching between the single spray pattern shower handset and fixed (rainfall) shower head easy whilst showering. Further functionality comes in the form of thermostatic temperature control, ensuring the shower holds a constant temperature for safe family showering, and a stylish safety glass shelf, useful for placing a shampoo.



Push Button Diverter Thermostatic Mixer Shower

- Push button diverter - Easily divert flow between single spray pattern handset and overhead fixed (rainfall) shower drencher
- Thermostatic temperature control - Maintains consistent, comfortable showering temperature
- Suitable for high pressure water systems only
- Includes stylish shelf - ideal for placing shampoo etc.
- Single spray pattern handheld shower head
- Single spray pattern fixed (rainfall) shower head
- 15mm push-fit (fixings to pipe) 3/4" flat face union (valve to fixings)
- 1.5m anti-twist hose

Ref: PBDIVBLK - **Black**
PBDIVCHR - **Chrome**



Thermostatic Mixer Showers

The Dene Range

Looking for style, versatility and an easy installation?

Our Dene range should be the very first thing on your list. Coming in a handsome, minimal, chrome design and suiting every kind of household water system, it really is the perfect all-rounder. If you wish to fit the shower yourself, then no problem, or if you're hiring a professional they'll thank you for the easy task. The only trouble will be choosing the right valve for you.



Dene Cool to Touch Bar Thermostatic Mixer for families

- TMV2 Thermostatic temperature control - maintains consistent, comfortable showering temperature
- Cool touch feature - ensures that the valve remains comfortable to touch
- Durable ceramic disc flow control
- Easy operation lever handle option available with the Dene Lever Bar Mixer
- Water saving option - select the Dene Eco CT bar mixer that will limit flow rate to a maximum of 6 l/min (ECODETHBM or Lever ECODETHBMLE)
- Automatic shutdown safety feature should either the hot or cold water supplies fail
- Shower kit - 3 spray rub clean shower head, 1.25m anti-twist hose, 530mm rail
- Includes all of the fittings, featuring the popular push-fit surface brackets
- Suitable for all systems, including gravity fed
- 5 year parts and labour guarantee



- Ref: UNDETHBMCT - Bar Mixer**
UNDETHBMCTLE - Lever Bar Mixer
ECODETHBM - Eco Bar Mixer
ECODETHBMLE - Eco Lever Bar Mixer

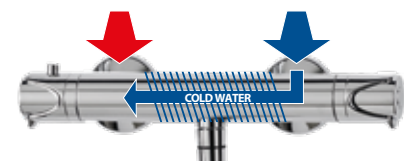

The cold supply runs across the valve before being mixed



Lever handle Bar Mixer also available

Built in version also available



Dene Concentric Thermostatic Mixer

- Accessible forward facing controls
- Suitable for all hot water systems including gravity fed
- 3 spray pattern rub clean shower head

Ref: UNDETHEXCM



Dene Sequential Thermostatic Mixer

- Single control for temperature adjustment with constant flow
- Suitable for all hot water systems including gravity fed
- 3 spray pattern rub clean shower head

Ref: UNDETHXSQM



Dene Bar Thermostatic Mixer with Diverter

This is to the standard bar mixer specification, plus the following:

- Diverts between pivot shower head and handset
- Handset is height adjustable for families
- Large diameter pivot shower head

Ref: UNDETHBMDIV

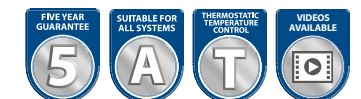

Matching taps available

It's also easy to complete the Dene look with some simple but stylish tap options



Dene Mono Basin Mixer with Click Waste
Ref: UNDETPBAM



Dene Basin Tap Pair with Click Waste
Ref: UNDETPBAS



Dene Bath Filler
Ref: UNDETPBF



Dene Bath Shower Mixer with Shower Head
Ref: UNDEBSM

Thermostatic Mixer Showers

EXE – Quality at a great price

Want quality, durability and value for money? Look no further than the Triton EXE range, offering a choice of bar mixers and bath shower mixers with two handle options. Featuring standard inlet centres, all are ideal for a quick product replacement. All EXE products will work with all hot water systems, including gravity fed. Co-ordinating taps are also available.



Exe Cool to Touch Bar Thermostatic Mixer

- Thermostatic temperature control - maintains consistent, comfortable showering temperature
- Cool touch feature - ensures that the valve remains comfortable to touch
- Durable design with ceramic disc temperature and flow control
- Easy operation lever handle option available with the Exe Lever Bar Mixer
- Automatic shutdown safety feature should either the hot or cold water supplies fail
- Shower kit - 3 spray rub clean shower head, 1.25m anti-twist hose, 530mm rail
- Suitable for all systems, including gravity fed
- 5 year parts and labour guarantee



Ref: UNEXTHBM - Bar Mixer
UNEXTHBMINC - Lever Bar Mixer



Standard Bar Mixer also available

Matching taps available

For a quick and easy replacement the EXE taps for either your bath or basin come as you would expect, with a choice of standard or lever handles. All come with manual temperature control.



EXE Lever Basin Tap Pair
Ref: UNEXTPBASLE



EXE Lever Bath Tap Pair
Ref: UNEXTPBTHLE



EXE Lever Bath/Shower Mixer
Ref: UNEXBSMINC



EXE Standard Basin Pair
Ref: UNEXTPBAS



EXE Standard Bath Tap Pair
Ref: UNEXTPBTH



EXE Bath/Shower Mixer
Ref: UNEXBSM



Thermostatic Mixer Showers

The Lentini Range

An ideal family shower, the Lentini thermostatic concentric mixer shower includes thermostatic temperature control, which compensates for any changes in water pressure to the shower, such as when someone else in the house turns on a tap or flushes a toilet. It has separate flow and temperature controls and includes a five spray pattern shower head.



Lentini Concentric Thermostatic Mixer (left)

- All chrome finish valve combined with elegant Lentini lever metal handles
- Separate forward facing, flow and temperature controls with clear handle markings
- Automatic shutdown safety feature should either the hot or cold water supplies fail
- Circular riser rail kit with adjustable top bracket and slider, 1.5m anti-twist chrome hose, 5 spray pattern shower head & bottle tray

Ref: XMLEXCM2



Lentini Extended Concentric Thermostatic Mixer (right)

- All chrome finish valve combined with elegant Lentini lever metal handles
- Separate forward facing, flow and temperature controls with clear handle markings
- New Installation kit available to allow this valve to retro-fit Triton's previous Eden valves
- Automatic shutdown safety feature should either the hot or cold water supplies fail
- Extended riser rail kit with easy to use controls, 5 spray pattern shower head and 2m anti-twist chrome hose

Ref: XMLEXCX3



Installation kit to allow this valve to retro-fit Triton's previous Eden valves



Digital Showers

Ideal for injecting a little high-tech into your first thing, digital showers blend first-rate performance with cutting-edge design, allowing you to start the unit remotely for maximum control.

Stylish, contemporary and highly personal the HOST digital shower should be the first thing on the shopping list for tech-savvy consumers. A wide range of mix-and-match accessories is also available to create the look you desire.

There's a digital option for every type of home hot water system including those with a combi boiler. Plus you can choose a single or dual outlet which includes a diverter to overhead shower or handset.



Digital Mixer Showers

HOST

With a number of top-spec features, HOST has been created by Triton's own designers to maximise your first thing, wherever and whatever it is. Incorporating features such as customisable pre-sets to save your favourite settings and a clear temperature read-out, plus a silent motor so your 5 minute morning escape is not disturbed.

All you have to do is turn on the shower and step in!

Key features and benefits

Shower comfort

The HOST digital mixer puts you fully in control of your showering experience with the following features.

Presets

Customisable presets store your favourite shower settings. Simply press one of three presets to go straight to your preferred shower.

- 'Just shower' provides regular shower settings
- 'Relax' offers a gentle spray (e.g. for rinsing)
- 'Energise' offers a powerful spray (e.g. post workout).

Alternatively simply fine tune your shower using 16 temperature and 10 flow levels. Customising your shower has never been easier with Triton's HOST.

Easy to read display

The full text, full colour easy to read display confirms the selected preset at start up and shows temperature and flow settings. Perfect for bleary eyes first thing.

Remote start/stop

The optional portable wireless remote start/stop with warm up function means you can turn on the shower while you grab a bit longer in bed. The warm up is completed in minutes and automatically stops should you return to the Land of Nod.

Peace and quiet

The HOST digital mixer is silent running, even the pumped low pressure version that uses new quiet motor technology. So whether you're a sun-up survivor or early morning escapist, you are free to shower any time of the day or night.

Shower choice

Create the perfect shower for your bathroom.

Designer finish

Combine with your choice of Mix & Match accessories (see pages 20 to 21) or select from the popular All-in-One packs.

For all systems

There is a HOST digital mixer shower for every type of hot water system including combi boilers. We have options for high or low pressure, so that means the HOST range is suitable for combis, mains cylinders and gravity fed cylinders – see pages 58-59.

Refurb or upgrade

Wireless so you are free to position the splash proof shower controller anywhere in the bathroom (within 10 metres of the processor unit). Also, no wires make it easy to upgrade any existing digital mixer shower.

Wireless or Wired

The shower controller is powered by 3x AA lithium batteries that are easy to change. Alternatively, route a 10m cable (supplied) where there is access to wall voids.



HOST black digital shower controller Available in the main shower packs below:

Single outlet mixer with controller

Ref: HOSDMS

Multi outlet mixer with controller

Ref: HOSDMM

Single outlet pumped (LP) mixer with controller

Ref: HOSDMSP

Multi outlet pumped (LP) mixer with controller

Ref: HOSDMMP

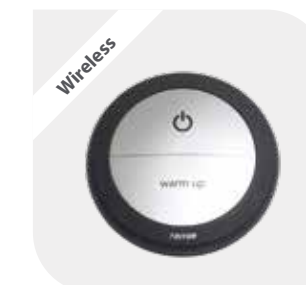

HOST remote start/stop

Ref: HOSDMRSS



HOST processor unit

Not available to purchase as a single unit

tritonshowers.ie



Dual Outlet Accessory Packs

Our most popular combinations. To help you select the accessories you'll need with your chosen mixer shower, here are four of our most popular Mix and Match combinations. Each one includes all you'll need to complete your shower – so you can be sure that nothing is forgotten!

For our full range of accessories please visit our website

Remember, when you choose Triton Affordable Style showering accessories they are all designed and tested to work perfectly with your shower.



COMBINATION PACK 1

Ref: TSPKDIVHHCIR

1. 200mm circular fixed head
2. 400mm circular wall arm
3. Circular wall shower head holder
4. Circular concealed wall outlet
5. 1.5m hose
6. Circular 1 position shower head



COMBINATION PACK 2

Ref: TSPKDIVRRCIR

1. 200mm circular fixed head
2. 400mm circular wall arm
3. Circular concealed wall outlet
4. Slender riser rail kit
5. 1.5m hose
6. Circular 1 position shower head



Match up a combi pack with our HOST Digital Mixer Shower



HOST Black Digital Shower



COMBINATION PACK 3

Ref: TSPKDIVHHSQ

1. Square edge 200mm fixed head
2. 400mm square edge wall arm
3. Square edge wall shower head holder
4. Square edge concealed wall outlet
5. 1.5m hose
6. Square edge 1 position shower head



COMBINATION PACK 4

Ref: TSPKDIVRRSQ

1. Square edge 200mm fixed head
2. 400mm square edge wall arm
3. Square edge riser rail kit
4. Square edge concealed wall outlet
5. 1.5m hose
6. Square edge 1 position shower head



Electric Showers

At Triton, we make showers. That's nothing world-changing, but we're trying to do our bit...

You see, electric showers help you save water, save energy... and so save money.

Meaning our customers can enjoy every wash without worrying.

Triton are famous for electric showers, and with good reason. Advanced shower technology and outstanding designs are combined to maximum effect in our extensive range.

From the stylish Amore DuElec™ electric diverter shower, to the easy to install T80 family, there's a model to match any bathroom or budget. Whichever you choose, all of our electric showers benefit from the Triton commitment to innovation, rigorous testing and affordable style.



Electric Showers

Amore

Sleek, modern and ultra-stylish, with clever fingertip touch controls and precise digital temperature readings to create and set your ideal showering experience. Amore is an elegant and easy-to-operate shower range you're sure to love using first thing. And with a choice of three smart finishes, Amore showers are irresistibly good looking too.



Gloss Black

Amore Electric Shower

- Choice of three finishes
- Available in 8.5kW and 9.5kW
- Digital display with temperature readout
- Contemporary sleek cover
- Accompanied by the slender kit, circular rub clean 5 mode shower head and clip-on bottle tray

Ref: ASPAMO8GSBLK – 8.5kW

ASPAMO9GSBLK – 9.5kW

ASPAMO8GSWHT – 8.5kW

ASPAMO9GSWHT – 9.5kW

ASPAMO8BRSTL – 8.5kW

ASPAMO9BRSTL – 9.5kW



Gloss White

Brushed Steel



Electric Showers

T80 Family

Triton's T80 family of electric showers has been an iconic household favourite for more than 30 years. Packed with design features that will appeal to both the homeowner and the professional installer. T80 showers feature the latest Swing-Fit™ and Swivel-Fit™ installation technology as well as delivering Triton style, quality and showering performance. A T80 shower makes it easy to create your perfect shower first time - both you and your installer will love it.



T80Z Fast-Fit Electric shower

Our T80 Fast-Fit has that unbeatable combination of an easy-to-install shower, classic looks and all at great value for money. Loved by families and installers alike the T80Z Fast-Fit has:

- 8 water and 6 cable entry points
- Makes it easy to replace any existing models
- Easy-to-use controls for both flow and temperature
- 5 mode Dura-Flow™ shower head that is easy to clean

Ref: XT80ZFI923 - (9.0kW - 230V) White

SP8007ZFF - 7.5kW White

SP8008ZFF - 8.5kW White

SP8009ZFF - 9.5kW White

SP8001ZFF - 10.5kW White

ECO8008ZFF - 8.5kW Eco

SP8CHR8ZFF - 8.5kW Chrome

SP8CHR9ZFF - 9.5kW Chrome

SP8CHR1ZFF - 10.5kW Chrome



What you should expect from a T80

An easy-to-install, stylishly designed electric shower, it's no wonder the T80 is one of our most popular units. Featuring up to eight water entry points and a sleek, simple look, the T80 is particularly popular as a replacement unit, coming highly endorsed by users and tradesmen alike.



T80Z Thermostatic Fast-Fit

The T80Z Thermostatic Fast-Fit also uses the Dura-Flow™ technology for a longer lasting shower, making it ideal for hard water areas.

With all the installation benefits of the Fast-Fit (see page 26) but with precise thermostatic temperature control, this T80 is ideal for busy households where someone is always using water, whether flushing the toilet or running a tap. Whatever is happening, the T80Z Thermostatic Fast-Fit will maintain your desired showering temperature.

- 8 water and 6 cable entry points
- Makes it easy to replace any existing models
- Easy to use controls for both flow and temperature
- 5 mode Dura-Flow™ shower head that is easy to clean

Ref: SP8008ZFFTHM - 8.5kW
SP8009ZFFTHM - 9.5kW
SP8001ZFFTHM - 10.5kW



Electric Showers

Rally II

With its sweeping curves, stylish compact design, elegant riser rail and shower head, this model not only offers exceptional value for money but will complement any bathroom.



Rally II Slimline Design

- Dial Temperature Control – easy to use dial to set your preferred showering temperature
- Dial power setting – cold-eco-high dial to select your seasonal power settings and to start/stop the shower
- Rub Clean Shower Head – Single spray pattern

Ref: XRAL21823 - (8.7kW - 230V)



Pumped Electric Showers

Looking for a low pressure showering solution? Then look no further. Triton has a range of pumped electric showers which have a built-in pump which boosts water flow to overcome low or unreliable water pressures.

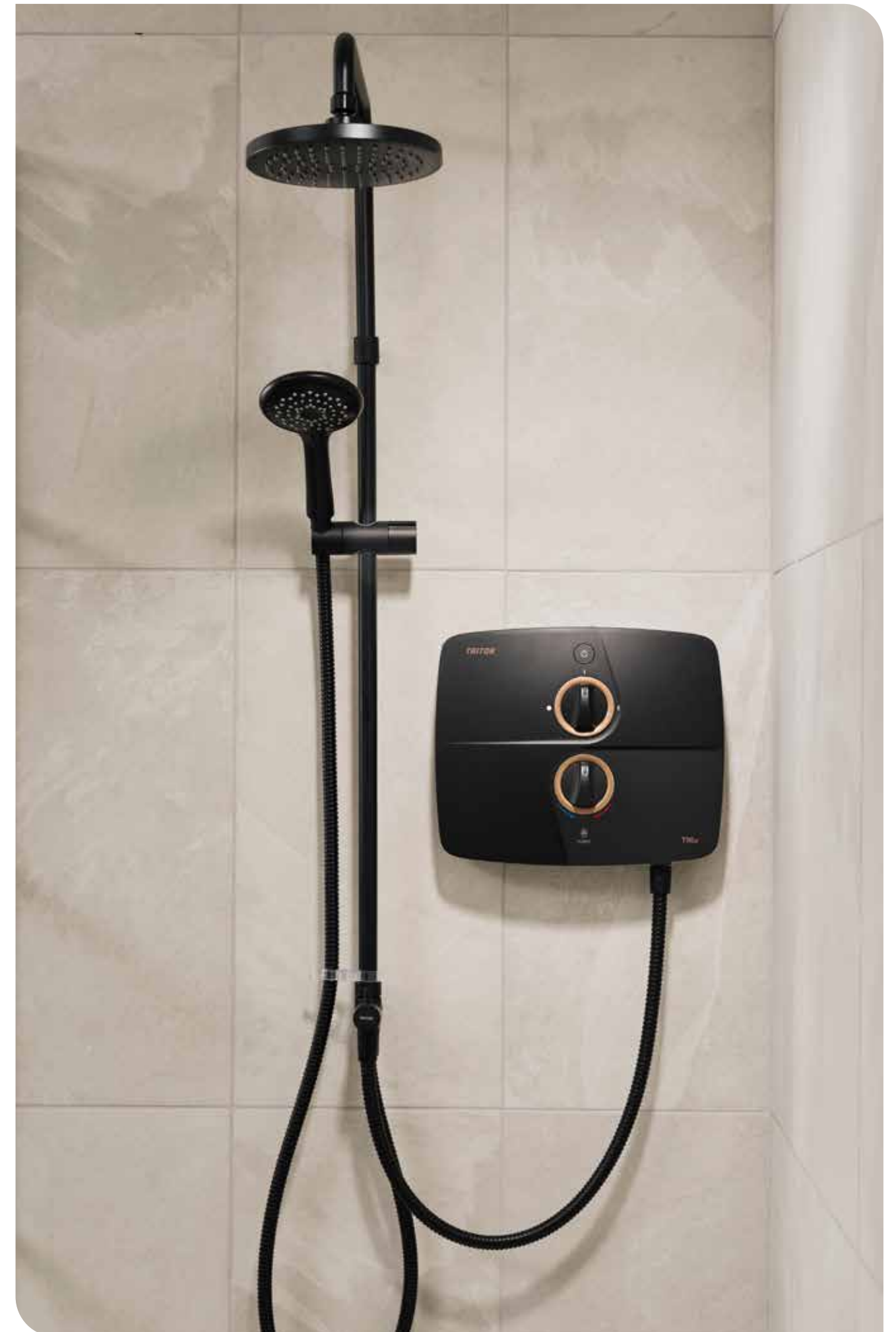

Pumped Electric Showers

T90SR

The new T90SR features the latest showering technology making it silent running, easier to install and deliver a better showering performance than its predecessors. Ireland's best selling shower has just got even better!



T90SR Pumped

Ref: XT9SRI953 (9kW - 230V) White/Chrome



T90SR Pumped

Ref: XT9SRISAT9 - (9kW - 230V) Satin/Chrome

Ireland's best selling shower has just got even better!

The T90SR, the first silent pumped electric shower - so quiet that you'll only hear the water!

The brushless motor technology means no motor noise and eliminates the accumulation of carbon dust making the T90SR more durable and longer lasting. By allowing the water to flow more freely inside the shower, coupled with the higher 9kW power rating, the T90SR delivers higher flow rates resulting in a revolutionary showering experience.

Replacing the previous T90 model is a breeze as the new T90SR and shower rail has the same footprint and fixing points. The water and cable entry points also remain the same for ease of installation.

- Manual Temperature Control - ergonomic settings for ease of use
- Integrated Pump - shower has a built in pump, ideal for homes where water pressure is low, unreliable or non existent
- Push Button Start/Stop - retains your preferred power and temperature settings
- Dial Power Setting - cold-eco-high dial to select your seasonal power settings
- LED 'Power On' Indicator
- 5 Spray Pattern Easy Clean Dura-flow™ Shower head - a removable 'push and twist' spray plate to clean those hard to reach places



Pumped Electric Showers

T90SR DuElec™

The T90SR DuElec™ is the latest addition to the T90SR Quiet Mark awarded range of pumped electric showers that provide users with a unique showering experience by switching seamlessly between the rainfall effect fixed shower head and the multiple spray pattern handset or even using the option of both outlets at the same time.

T90SR DuElec™ Pumped

- Seamlessly divert between the large fixed shower head and the 5 spray pattern hand set or alternatively run them both at the same time
- Quiet Mark awarded integrated pump significantly reduces noise traditionally expected from pumped electric showers
- The digital brushless motor effortlessly boosts the water pressure of gravity fed systems
- 9.0kW rating and new free flowing components allow higher flow rates
- Easy prime pump allows water flow without the need to operate the pump
- Multiple entry points for pipe and cable, and ideal shape for replacing previous T90 models
- Now an even better alternative to a mixer shower on a gravity system, able to operate at lower head gravity and typically offering better flow rates and an improved showering experience

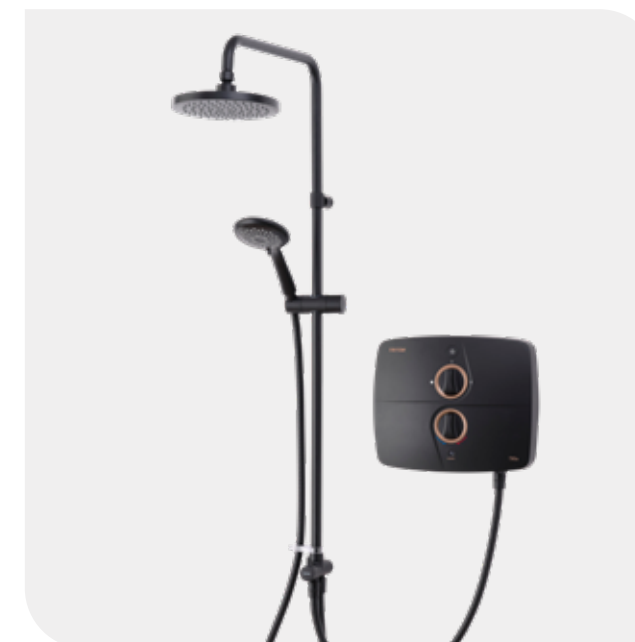

T90SR DuElec™ Pumped

Ref: XE90DU93 (9kW - 230V)

Matte Black Finish With Copper Trim

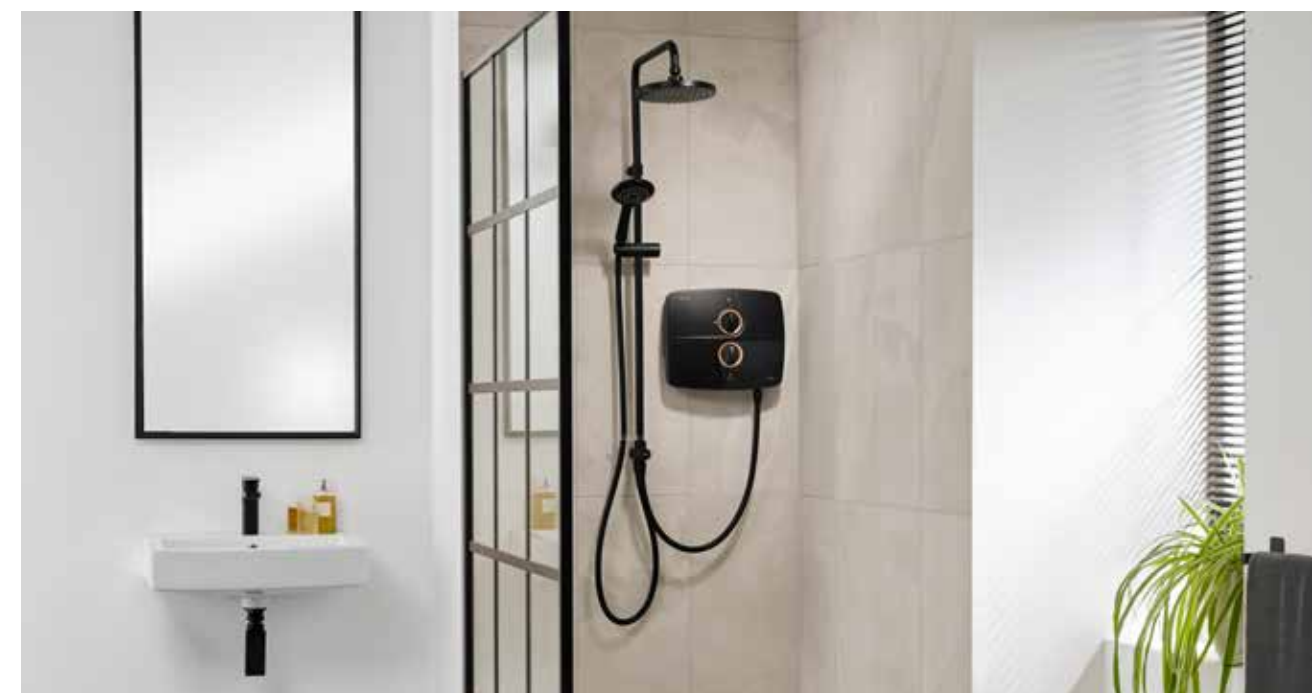

Pumped Electric Showers

T900SR

As a tank fed integral silent running pumped electric shower the T900SR is an excellent solution to low or negligible water pressure installations. This design classic combines solid form and easy to use control features, complemented with an elegant curved riser rail.



T900SR Pumped

- Ideal electric shower solution for low mains water pressure sites
- Push Button Start/Stop – to select your favourite shower setting every time
- Separate flow and temperature controls
- Easy clean DuraFlow™ 5 spray pattern shower head with removable spray plate
- Anti-twist 1.25m hose

White/Chrome

Ref: XET90PSR91 - (9kW - 230V)



Pumped Electric Showers

Omnicare SR Pumped

Featuring intuitive easy to use operating controls. This silent running pumped shower has BEAB CARE thermostatic performance, for extra safety assurance RNIB accreditation with the added benefit of a pump for use when water pressure is low or unreliable.



Omnicare SR Pumped

- Quiet Mark awarded integrated pump significantly reduces noise traditionally expected from pumped electric showers
- Precise thermostatic control constantly regulates water temperature (BEAB Care Standard)
- RNIB approved tactile design for visually impaired users
- Large soft press start/stop button
- Easy operation - tactile low resistance centralised temperature control dial
- Audible feedback offers assistance on start/stop & shower duration operation
- Set the duration of the shower ranging from 5 minutes to 30 minutes
- Extended shower kit - 2m anti-twist hose with 940mm riser rail
- Single hand operated handset holder with easy push system
- Easy clean inclusive 5 spray pattern shower head with removable spray plate
- 2 year parts and labour guarantee
- Efficient A energy rating

White/Grey/Chrome

Ref: XEOSRP81 - (8.5kW - 230V)



Care Showers

Style doesn't need to be sacrificed for function. Inclusive showering should mean you can have the stylish products you desire in your home and that everyone finds them easy to use day after day.

As the manufacturer of the UK's favourite shower, it is only natural that we would want everyone to be able to enjoy showering. That's why in 2000, we were the first to produce an electric shower specifically designed for the care market. Through in depth discussions with OT's, carers and organisations such as the RNIB and BEAB, Triton has continued to develop a variety of innovative solutions to aid independent living. Design features such as audible feedback and easy-to-use operating controls are just some of the benefits which Triton's extensive range has to offer.

All products in this carefully selected range have thermostatic temperature control as well as easy to use, intuitive controls.

Care Showers

Omnicare

The new Omnicare has all the Safeguard⁺ and T150⁺ safety features you should expect from a Triton 'Inclusive Shower', but as styling has evolved so has Omnicare. With its new sleek form, the option of two designs and minimalist simplistic look, this shower ticks all of the inclusive showering boxes. The user has all the benefits of a BEAB Care approved shower without having to compromise the styling of their bathroom.



Omnicare

Omnicare provides the ideal solution to the difficulty of finding a shower which is both stylish for the bathroom and can be easily used by everyone. BEAB Care mark approved thermostatic temperature control ensures the shower maintains the chosen temperature within +/- 1 degree, whilst extended riser rail and 1.5m shower hose accessories ensure the shower can be used whether seated or stood in the shower.

- BEAB CARE mark - Keeps water temperature within +/- 1°C for total peace of mind
 - Timed auto shutdown – 5, 10, 20 or 30 mins (default 20 mins)
 - Controls - Low resistance operation and soft press start/stop button
 - Connection - connects to analogue waste pump
 - Assistive accessories – Comes with extended 680mm riser rail kit with adjustable fixing centres and extended 1.5m anti twist shower hose
 - Single hand operated handset holder with easy push system
 - Large soft press start/stop button
 - Power on illumination along with audible feedback allows ease of use for all users
 - Easy to use low resistance centralised temperature control
 - Constantly regulating water temperature within +/- 1°C, (BEAB Care standard)
 - Adjustable max temperature – 41°C or 43°C
 - Easy clean inclusive 5 spray pattern shower head with removable spray plate
 - Multiple pipe and cable entry points, a generous footprint and a fixing hole kit, the Omnicare is designed with ease of replacement in mind
 - Simple 2 minute commissioning process
 - 2 year parts and labour guarantee
 - Efficient A energy rating
- Ref: TEOMN81 - (8.5kW)
TEOMN91 - (9.5kW)
TEOMN281 - (8.5kW with 2m Hose)
TEOMN291 - (9.5kW with 2m Hose)





Omicare Design with Grab Kit

Ref: TEOMNDG81 - 8.5 kW
TEOMNDG91 - 9.5 kW



Omicare Design with Extended Kit

Ref: TEOMND281 - 8.5kW
TEOMND291 - 9.5kW
XEOMND81 - 8.5kW
XEOMND91 - 9.5kW

Omicare Design

- Large soft press start/stop button and low resistance control dial
- Power on illumination along with audible feedback allows ease of use for all users
- Timed auto shutdown – 5, 10, 20 or 30 mins (default 20 mins)
- Tactile temperature dial with soft grey tones offers helpful visual contrast
- Constantly regulating water temperature within +/- 1°C, (BEAB Care standard)
- Set the duration of the shower ranging from 5 minutes to 30 minutes
- 2m hose and large easy clean 5 spray pattern shower head, with removable faceplate (no tools required)
- Multiple pipe and cable entry points, a generous footprint, the Omnicare is designed with ease of replacement in mind
- The Omnicare Design connects to analogue waste pumps
- Simple 2 minute commissioning process

Design:

- Stylish form with a variety of finish choices – an option to suit all bathrooms
- Tactile temperature dial with soft grey tones offers helpful visual contrast
- A choice of kit depending on your needs; extended kit for more flexibility while showering, or the grab kit for the optimum safety and support
- The Omnicare Design is compatible with analogue waste pumps
- With multiple pipe and cable entry points, a generous footprint and a kit for plugging any existing holes in your wall, the Omnicare is designed with ease of replacement in mind

Safety:

- Constantly regulating water temperature within +/- 1°C, the Omnicare gives the maximum temperature reassurance with the BEAB Care mark
- Adjustable max temperature – 41°C or 43°C
- The Design unit has RNIB approval
- Safe-set™ allows the maximum temperature to be set whilst allowing full rotation of temperature dial
- Choice to set the duration of the shower ranging from 5 minutes to 30 minutes, for extra peace of mind whilst showering
- Dual purpose grab rail option is designed to withstand up to 150kg support load, providing a stylish grab rail option if and when it is needed
- Power on illumination along with audible feedback allows ease of use for all users

Simplicity:

- The soft press start/stop requires very little effort when wanting to start or stop your showering experience
- Looped lever handle in the centre of the unit for intuitive use, with its low resistance operation the perfect showering settings can be achieved easily
- With a 2m hose and a lower level handset holder offered with the grab rail, this gives you the flexibility of a seated or standing shower



To find out more about our inclusive accessories including our unique grab kit

See page 44 - 45

Elina

Elina mixer showers offer key features to help users lead more independent lives, without compromising on styling.

This Triton 'Inclusive Showering' Mixer Range is Type 3 TMV accredited and ideal for bathroom adaptations, commercial healthcare applications and nursing homes.



Elina TMV3 Concentric Mixer – Built-in

With its striking cylindrical face, the built-in Elina delivers the style and functionality that you would expect from all Triton showers.

Ref: ELICMINCBT (Valve and grab kit)
ELICMINCBTVO (Valve only)

Elina TMV3 Concentric Mixer – Exposed

This exposed mixer is available with separate flow and temperature controls for ease of use.

- Separate flow temperature controls
- Accessible front facing level controls that are easy to turn
- Automatic shutdown if hot and cold supplies fail
- Simple to install and maintain
- Factory set maximum temperature at 38°C
- Ideal for use in care homes, hospitals and nursing homes

Ref: ELICMINCEX (Valve and grab kit)
ELICMINCEXVO (Valve only)

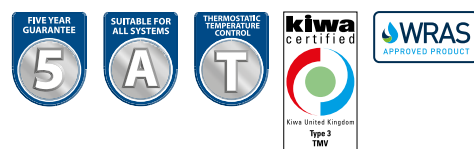

Elina TMV3 Inclusive Bar Mixer Shower

Stylish, sleek and robust. The Elina TMV3 Bar Mixer has tamper-proof, separate controls for flow and temperature.

- Separate flow and temperature controls
- Tamper-proof lever controls
- Automatic shutdown if hot and cold supplies fail
- Simple to install and maintain
- Factory set maximum temperature at 38°C

Ref: ELITHBMINC3 (Valve and grab kit)
ELITHBMINC3BOT (Valve only)



Elina TMV3 Sequential Mixer Shower

Exposed Simple and easy to use, with its single control, the Elina sequential mixer also has TMV3 thermostatic performance for extra safety assurance giving you peace of mind for all the family.

Ref: ELITMV3EXSL (Valve only)

Built-in Designed to fit flush to your wall giving a chic look to your bathroom, the Elina Built-in features the same operating and thermostatic features as the Elina Exposed. Choose from our selection of riser rail kits and shower heads to suit your needs.

Ref: ELITMV3BTSL (Valve only)

- TMV3 Thermostatic Control – constantly regulated temperature gives the user more precise control and safer showering
- Automatic Shutdown – should either hot or cold water supplies fail
- Single control – for temperature adjustment with constant flow
- Tamper proof lever control
- Factory set maximum temperature at 38°C
- Ideal use for care homes, hospitals and nursing homes
- Shower kit, riser rail and shower head each sold separately
- See our accessory range on page 44 - 47



Care Riser Rails, Kits and Hoses

All designed and tested to be used comfortably whether standing or sitting whilst showering. Available in chrome or white to complement your choice of shower.



Triton's standard care kit (White) includes:

- 680mm or 940mm brushed stainless steel riser rail
- Single hand operated handset holder with easy push system
- An easy to use and easy to clean shower head with adjustable settings
- Choice of 1.5m or 2m hose ideal for both users and carers

**Inclusive Care Riser Kit:
1.5m hose, 680mm rail - White**

Ref: GAUF1

2m hose, 940mm rail - White

Ref: GAOMDF1



1.5m Chrome Hose
Ref: XTSHG150C

2m Chrome Hose
Ref: TSHG1266



Triton's standard care kit (Chrome) includes:

- 940mm stainless steel polished riser rail
- An easy to use and easy to clean shower head with adjustable settings
- 2m hose ideal for both users and carers

Inclusive Care Riser Kit - Chrome

Ref: TSKCARESTDCHR



Triton's grab riser rail care kit (White) includes:

- 940mm brushed stainless steel grab riser rail able to withstand up to 150kg support load to provide extra reassurance while showering
- An easy to use and easy to clean 5 position shower head
- Single hand operated handset holder with easy push system
- 2m hose ideal for both users and carers

A separate shower head holder is also available giving extra flexibility whether standing or sitting (see below).

Inclusive Extended Grab Riser Rail Kit - White

Ref: GAOMDGF1



Triton's grab riser rail care kit (Chrome) includes:

- 940mm polished stainless steel grab riser rail able to withstand up to 150kg support load to provide extra reassurance while showering
- An easy to use and easy to clean 5 position shower head
- 2m hose ideal for both users and carers

A separate shower head holder is also available giving extra flexibility whether standing or sitting (see below).

Inclusive Extended Grab Riser Rail Kit - Chrome

Ref: TSKCAREGRBCHR



Lower Shower Head Holder

Ref: CSGPHHCHR - Chrome (shown)

CSGSPHHWHT - White

Shower Accessories

Beautiful showers deserve beautiful surroundings. That's why Triton have designed a range of accessories with the same attention to detail, quality and style as our showers.

Ideal for most shower installations, Triton have a great range of accessories to choose from. Shower heads for electric, mixer and power showers offer a choice of spray patterns to suit your mood and our riser rails include an adjustable bracket which allows you to alter the height and angle of the shower head.

Shower Accessories

Why Triton Accessories?

Did you know that Triton tests all its shower accessories to ensure they deliver the optimum performance from our showers?

We also consider them to be safety recommended items, ensuring hassle-free showering day after day. So if you're looking to refresh your shower, look no further than our selection of Triton accessories.

**TRITON SAFETY
RECOMMENDED**



Alfie Slider
Ref: XALFSLID10 - White



Archie Slider
Ref: XARCHISLID10 - White



Hose
Ref: XSHCHER5 - Chrome - 1.25m
XTTSHER103 - Chrome - 1.75m



8000 Series Shower Head
Ref: XSH800ER4 - White
XSHP800ER4 - for pumped
product compatibility



Alfie Kit
Ref: XALFWCKIT4 - White/Chrome



DuElec™ Kit
Ref: XADUKIT2 - Chrome

tritonshowers.ie

To view our full range, visit tritonshowers.ie/shower-accessories
Always make sure you choose the correct accessory suitable for your chosen shower.

Power Showers

Triton's silent running thermostatic power shower is so quiet that when the water is running, you won't hear the pump, and as such has been awarded the Quiet Mark award of approval.

This means that there is no need to worry about disturbing the rest of the household with a noisy pumped shower.

Power Showers

NovelSR

Triton's NEW silent running thermostatic power shower is so quiet that when the water is running, you won't hear the pump, and as such has been awarded the Quiet Mark award of approval.



NovelSR - Silent Running Thermostatic Power Shower

The NovelSR is the perfect solution for those with low pressure systems, providing a great flow rate of up to 14 litres per minute. Its continuous running performance ensures there is no waiting around in between showers for busy families.

- Easy to use start/stop button
- Thermostatic control constantly regulates the temperature providing you with precise control and a safer showering experience
- Adjustable maximum temperature stop reduces the risk of accidentally turning the temperature too high
- Multiple cable and water entry points including the Triton Swivel Fit Water Inlet, enabling top, rear or bottom entry for ease of installation
- Larger footprint makes it an ideal replacement for existing Triton power shower models
- Large 5 mode, rub clean shower head
- 1.25m anti-twist hose
- 2 year guarantee, full parts and labour

Ref: XIPSTHMSRI



Handwash & Water Heaters

Instantaneous water heaters heat water where only a cold mains water supply is available (such as in a utility room or commercial environment).

The water heater powers up when water starts to flow through the unit (such as when a tap is opened) and uses no power when it is in standby operation, providing a very economical solution for hot water on demand. Triton has a range of kilowatt options and sizes available to suit a variety of needs - including under-sink options from the Triton Instaflow range. Whether for a hand basin tap for heating water on demand for handwashing, 2 outlets or a kitchen tap, there is a solution in the Triton water heater range.



Instaflow T30I & T30IR

A compact unit, T30IR is perfect for fitting into small spaces and providing a source for instant hot water where only a cold mains water supply is available.



T30I Handwash

The T30I Handwash is designed as a compact unit, making it perfect for fitting into small spaces and providing a source for instant hot water where only a cold mains water supply is available.

Perfect for handwashing...helping minimise the risk of Covid-19

See also: A hands free, infra-red (IR) operated version of the Instaflow T30 handwash is also available (sold separately)

- Single control for start/stop and temperature selection
- Heats water on demand - ideal for handwashing where only a cold mains water supply is available
- Quick and easy to install
- Direct replacement to the Triton T30I
- NEW 100mm swivel arm accessory option available, providing an option for any basin size (200mm arm supplied as standard)
- 2 year parts and labour guarantee

Ref: XTSP303I - 3kW



T30IR Handwash

With all the great features of the manual Instaflow T30i handwash, the T30IR provides the additional benefit of hands free operation with the Infra-red (IR) sensor, ensuring hygienic conditions can be maintained.

A compact unit, T30IR is perfect for fitting into small spaces and providing a source for instant hot water where only a cold mains water supply is available. Ideal for a cloakroom or toilet with no hot water supply, utility room or commercial environment such as a workshop or garage.

Perfect for handwashing...helping minimise the risk of Covid-19

- Seasonal temperature adjustment provides optimum performance all year round, eliminating the need for constant adjustment
- On/Off Infra-red motion sensor
- Direct replacement of the Triton T30I
- Timed shut down ensures minimal water wastage
- NEW 100mm swivel arm accessory option available, providing an option for any basin size (200mm arm supplied as standard)
- 2 year parts and labour guarantee

Ref: XTSP303IR - 3kW



Instantaneous Water Heating

Instaflow

Introducing a **Brand New Range** of instantaneous water heaters from a brand expert in electric water heating, triton showers.

Instaflow has been designed to provide hot water on demand for both single and multipoint outlet applications. With a range of different kW options and sizes, we provide a solution for every requirement.



Instaflow Single Point Water Heater

A compact designed unit, great for under-sink installations as a perfect fit space saving option and ideal for hand washing. The Single Point 5.4kW Water Heater provides instantaneous hot water on demand to a single outlet such as a handbasin.

- Heats the water when it starts to flow, for an economical hot water solution as no power is used when in standby operation
- Power selection is smooth and easy for optimum settings selection
- Suitable for a single hand basin
- Can be used with manual mixer taps
- IPX4 splash proof rated
- 1 year parts and labour guarantee

Ref: SPINSF05SW - 5.4kW



Instaflow Multi Point Water Heater

The Multi Point Water Heaters are designed to be wall mounted, and provide instantaneous hot water on demand to two outlets such as two hand basins. Available in 7.7kW and 10.1kW, they are perfect for under-sink installations as a space saving option in a property.

- Heats the water when it starts to flow for an economical hot water solution as no power is used when in standby operation
- Ideal for supplying hot water where there is only a cold mains supply
- Suitable for a single outlet or two outlets in a property, for example one kitchen sink or two hand basins
- Power selection is smooth and easy for optimum settings selection
- IP25 water ingress protection

Ref: SPINSF07MW - 7.7kW
SPINSF10MW - 10.1kW

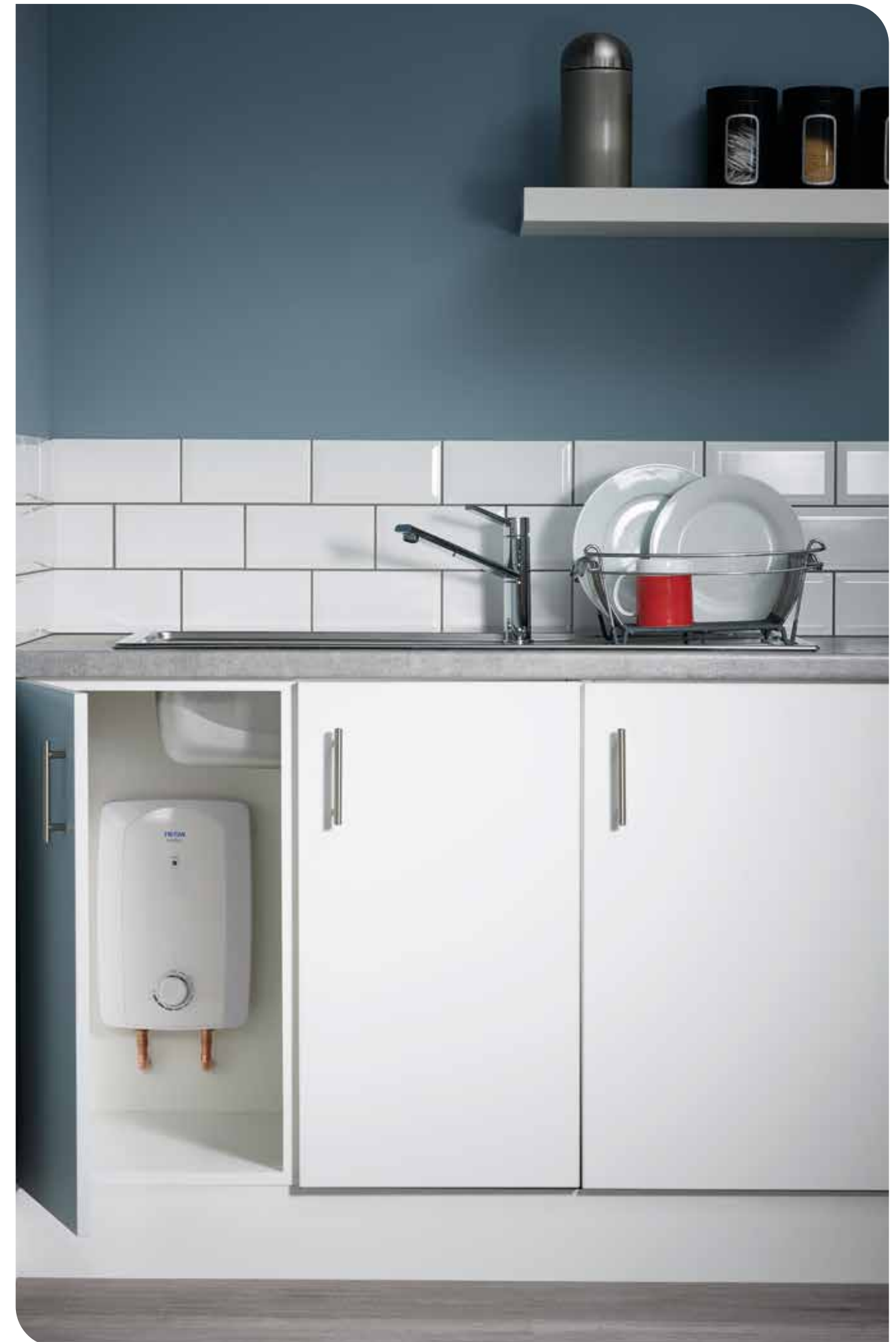

Stored Water Heating

Instaflow

The Instaflow stored water heater provides high flow rates and is perfect for storing up to either 5, 10 or 15 litres of hot water from a cold mains water supply

Instaflow Stored Water Heater

- Stored hot water heater fed by cold mains water supply
 - Available as 5l, 10l or 15l capacity
- Everything supplied for ease of installation (additional accessories available if required)
- Under-sink installation with top connectors
- Quick heat up times and variable temperature settings (with a maximum temperature of 75°C)
- Corrosion resistant, enamel coated heater tank with magnesium anode protection
- 2 year parts and labour guarantee
- Efficient B energy rating

Ref: SPINSF500S - 1.5kW - 5L
SPINSF100S - 2kW - 10L
SPINSF150S - 2kW - 15L



Get it right first time

Help me choose

So now you have browsed through the Triton showers available, you will need to check which showers work with your home's water system. This section will guide you through the process to make the right selection for you.

Mixer



Electric

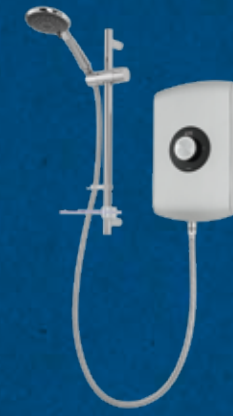

Digital



What shower can I have?

One of the first questions you need to ask when you're choosing a new shower is "Do I have a High or a Low pressure hot water system?". This is because it will determine the type of shower unit that is suitable and will give you the best performance.

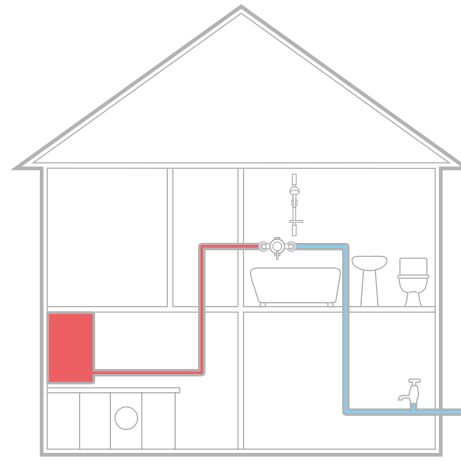
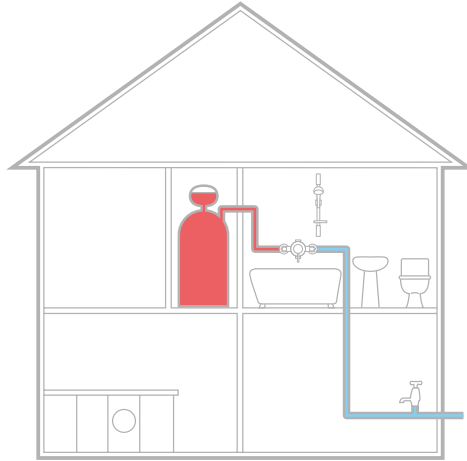

High Pressure Water Systems

Mains Unvented Cylinder

If you have a hot water tank (cylinder), usually found in your airing cupboard, but you don't have a cold water tank (cistern) in your loft, this is an unvented high pressure system. This can look similar to a low pressure system so check carefully to avoid confusion. Also take caution in refurbished houses with disused water tanks.

Mains Combi

If you have a combination (combi) boiler which heats water on demand so there is no hot water storage cylinder or cold water tank, you have a high pressure system.

If you have either of these two set-ups, simply choose from our extensive range of High Pressure showers indicated by the relevant symbol illustrated above (H or A).

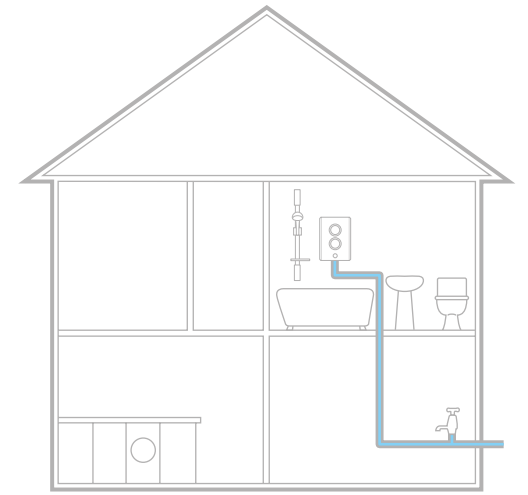
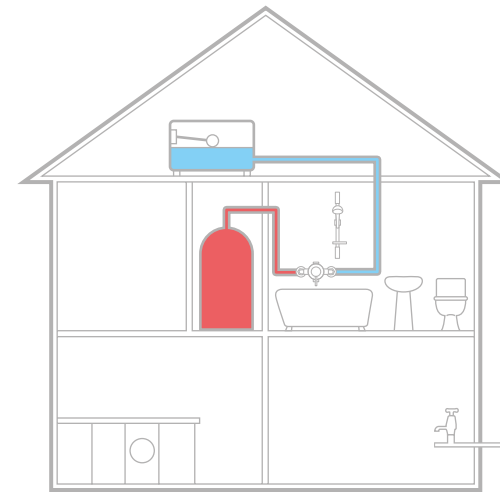

Low Pressure Water Systems

Gravity Fed

If you have a cold water tank (cistern) in your loft and a hot water tank (cylinder) in your airing cupboard, this is a gravity-fed system. It's the most common household plumbing system and means you have a low pressure water system. Having low pressure need not limit your choice of shower type. Simply choose from our extensive range of low pressure suitable showers indicated by the symbol above.

Cold Mains

Most Electric showers can be connected to a cold water mains supply. Simply choose from our extensive range of Electric showers indicated by the relevant symbol illustrated above. If your cold mains does not have the required regulated minimum water pressure, see pages 32-37.



Low pressure water systems when used with a pump

As low pressure water systems above, but only suitable if used with a pump as indicated by the relevant symbol illustrated above (P).



Electric showers are all guaranteed for 2 years for domestic use, with the option to extend to 5 years.

Euro Standards

Water Efficiency Label - Applicable for Mixer Showers

Triton Showers is proud to be a registered member of the Bathroom Manufacturers Association. The BMA 'Water Efficiency Label' provides a recognisable, consistent measure of water usage for domestic water appliances; designed to help consumers and installers choose a product.

For more information visit www.europeanwaterlabel.eu



EU Energy Efficiency Label - Applicable for Electric Showers

Bathroom manufacturers across the globe are aiding governments in their quest to reduce water consumption by producing innovative and technologically advanced bathroom products that deliver a bathing experience customers can enjoy while saving water and energy.

The scheme provides easy access to a database of bathroom products which when installed and used correctly will use less water, save energy and save money.

For more information visit www.newenergylabel.com

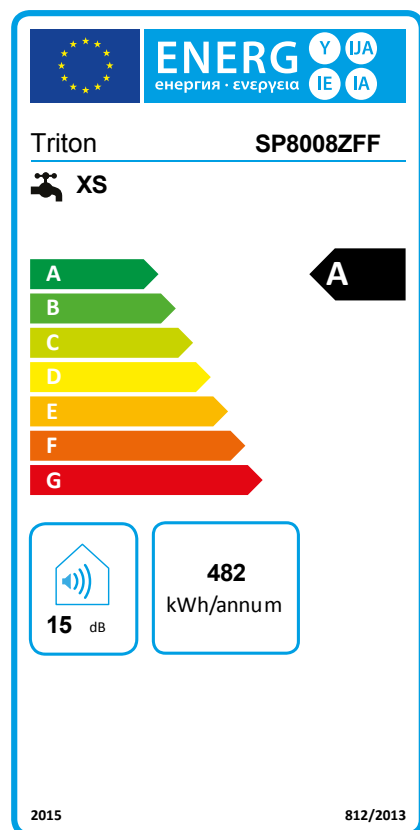

Bar Mixer Shower Fixing Bracket

An easy fit option that eliminates the need to measure distance between the inlet centres and accommodates a building-in depth as little as 30mm from the plasterboard face. It also comes with push fit fittings, flow limiters and filters to simplify future maintenance. Suitable for most types of bar mixer and wall mounted bath/shower mixers with 3/4" BSP fittings including the extensive Triton range.

Ref: UNBMXBKT

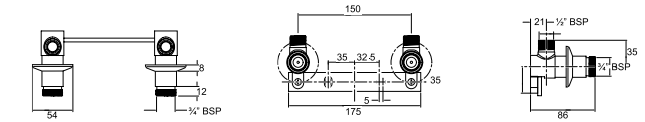

Dimensions given are approximate.

1. Fit the elbows to the bracket using the screws provided.
2. Secure a fixing baton to the depth required in the stud wall and fix the bracket using the screws provided.
3. Complete the pipe work to the elbows and make good the walls.
4. Once the tiling is complete you simply fit the trims and push-fit the seals into the outlets, inserting flow regulators if required. You are now ready to fit and secure the bar mixer.

Mixer Shower Fixing – Exposed Pipe work

Fittings designed with no exposed screws and requires only one drill hole through the tiling for each bracket. Flow limiters and filters are also included to simplify future maintenance.

Suitable for most types of bar mixer and wall mounted bath/shower mixers with 3/4" BSP fittings including the extensive Triton range.

Ref: UNBMXFIXEX

1. Secure the bracket mounting plates to the wall using the screws provided. Ensure the distance between the mounting plate centres is equal to the distance between the bar mixer inlet centres.
2. Slide the brackets onto the mounting plates and secure using the grub-screw in the base.
3. Slide the nut and olive onto the in-coming pipe work and fit the pipe work into the bracket. Tighten the nut for a watertight seal.
4. You then simply push-fit the seals into the bracket outlets, inserting flow regulators if required. You are now ready to fit and secure the bar mixer.

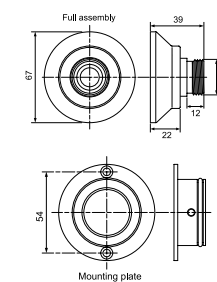

Dimensions given are approximate. For Bar Diverter mixer showers please check suitability.

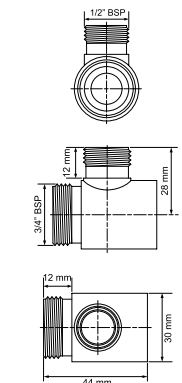

Dimensions given are approximate. For Bar Diverter mixer showers please check suitability.

Mixer Shower Fixing – Exposed Pipe Tails

Fittings designed to leave no exposed thread between the trim and the bar mixer. The push-fit connections make installation even faster they also include flow limiters and filters to simplify future maintenance.

Suitable for most types of bar mixer and wall mounted bath/shower mixers with 3/4" BSP fittings including the extensive Triton range.

Ref: UNBMXFIXBT

1. Complete the pipe work to the bracket mounting points, leaving an excess of pipe protruding out of the wall and make good the walls and tiles.
2. Press a push-fit connector onto each pipe, screw the mounting plates onto the connectors and fix in place using the screws provided.
3. A grub screw in the mounting plate secures the connector and you can now seal the joint between the mounting plate and the wall using a suitable sealant.
4. You then simply push-fit the cover trims onto the mounting plates and push-fit the seals into the outlets, inserting flow regulators if required. You are now ready to fit and secure the bar mixer.

Shower specifications

T90SR

pumped electric shower
9kW (230v) ROI only

Temperature Control	Pumped electric stabilised
Power Ratings	9kW (230v)
Inlet Connection	15mm compression
Water Entry Points	Top, bottom, back (left hand side of unit)
Cable Entry Points	Top, bottom, back (left hand side of unit)
Outlet Connection	1/2" BSP
Plumbing System	Cold water cistern only
Minimum Head Pressure	75mm
Maximum Head Pressure	10m
Surface Mounted Only	
Approvals, Complies with	BEAB, CE, BSI Kitemark
Guarantee	2 years

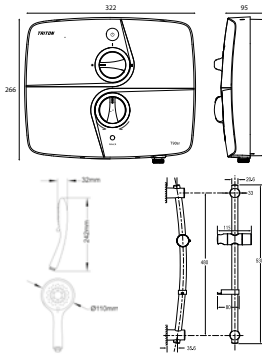

Finish	Power	Code
Satin/Chrome	9kW	XT9SRISAT9
White/Chrome	9kW	XT9SRIS93

T90SR DuElec™

pumped electric shower
9kW (230v) ROI only

Temperature Control	Pumped electric stabilised
Power Ratings	9kW (230v)
Inlet Connection	15mm compression
Water Entry Points	Top, bottom, back (left hand side of unit)
Cable Entry Points	Top, bottom, back (left hand side of unit)
Outlet Connection	1/2" BSP
Plumbing System	Cold water cistern only
Minimum Head Pressure	75mm
Maximum Head Pressure	10m
Surface Mounted Only	
Approvals, Complies with	BEAB, CE, BSI Kitemark
Guarantee	2 years

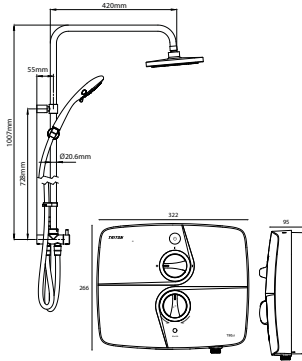

Finish	Power	Code
Matte Black Finish With Copper Trim	9kW	XE90DU93

T900SR

pumped electric shower
9kW (230v) ROI only

Temperature Control	Pumped electric stabilised
Power Ratings	9kW (230v)
Inlet Connection	15mm compression
Water Entry Points	Top, bottom, back (left hand side of unit)
Cable Entry Points	Top, bottom, back (left hand side of unit)
Outlet Connection	1/2" BSP
Plumbing System	Cold water cistern only
Minimum Head Pressure	80mm
Maximum Head Pressure	10m
Surface Mounted Only	
Approvals, Complies with	BEAB, CE, BSI Kitemark
Guarantee	2 years

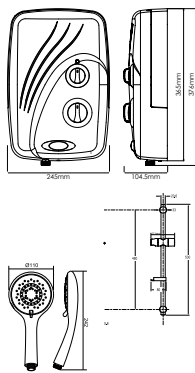

Finish	Power	Code
White/Chrome	9kW	XET90PSR91

Omnicare SR Pumped

thermostatic electric shower
8.5kW (230v)

Temperature Control	Thermostatic Pumped Electric
Power Ratings	8.5kW (230v)
Inlet Connection	15mm compression
Water Entry Points	Top, bottom, back (right hand side of unit)
Cable Entry Points	Top, bottom, back (right hand side of unit)
Outlet Connection	1/2" BSP
Plumbing System Compatibility	Cold water cistern only (Gravity fed system)
Minimum Head Pressure	80mm
Maximum Head Pressure	10m
Surface Mounted Only	
Approvals, Complies with	BEAB, BEAB CARE, RNIB, CE, BSI Kitemark, Quiet Mark
Guarantee	2 years

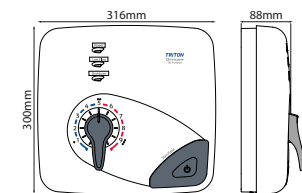

Finish	Power	Code
White/Grey/Chrome	8.5kW	XEOSRP81

Omnicare

thermostatic electric shower
8.5kW and 9.5kW (240v)

Temperature Control	Thermostatic
Power Ratings	8.5kW, 9.5kW (240v)
Inlet Connection	15mm swivel inlet (up/down)
Water Entry Points	Top, bottom back, bottom (right hand side of unit)
Cable Entry Points	Top (left hand side of unit) Top, bottom back, bottom (right hand side of unit)
Outlet Connection	1/2" BSP
Waste pump connection(s)	Analogue
Plumbing System Compatibility	Mains cold water only
Minimum Running Pressure/Flow	Min maintained pressure: 0.5 bar Min maintained pressure for BEAB Care: 1.0 bar
Maximum Static Pressure	10 Bar
Surface Mounted Only	
Approvals, Complies with	BEAB CARE, CE, BSI Kitemark, IP25, UKCA
Guarantee	2 years

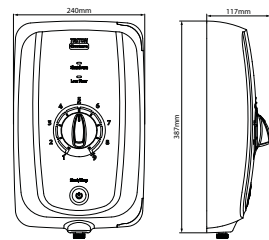

Product	Power	Code
Omnicare	8.5kW	TEOMND81
Omnicare	9.5kW	TEOMN91
Omnicare with 2m Hose	8.5kW	TEOMN281
Omnicare with 2m Hose	9.5kW	TEOMN291

Omnicare Design

thermostatic electric shower
8.5kW and 9.5kW (240v)

Temperature Control	Thermostatic
Power Ratings	8.5kW, 9.5kW (240v)
Inlet Connection	15mm swivel inlet (up/down)
Water Entry Points	Top, bottom, back (right hand side of unit)
Cable Entry Points	Top (left hand side of unit) Top, bottom, back (right hand side of unit)
Outlet Connection	1/2" BSP
Waste pump connection(s)	Analogue & Digital (wired)
Plumbing System Compatibility	Mains cold water only
Minimum Running Pressure/Flow	Min maintained pressure: 0.5 bar Min maintained pressure for BEAB Care: 1.0 bar
Maximum Static Pressure	10 Bar
Surface Mounted Only	
Approvals, Complies with	BEAB, BEAB Care, RNIB, CE, BSI Kitemark, IP25, UKCA
Guarantee	2 years

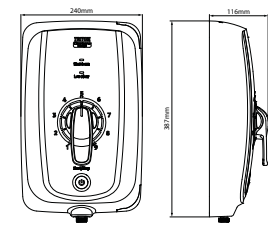

Product	Power	Code
with Grab Kit	8.5kW	TEOMNDG81
with Grab Kit	9.5kW	TEOMNDG91
with Extended Kit	8.5kW	TEOMND281
with Extended Kit	9.5kW	TEOMND291
with Extended Kit	8.5kW	XEOMND81
with Extended Kit	9.5kW	XEOMND91

Elina Inclusive TMV3 Concentric Exposed Mixer

thermostatic mixer shower

Temperature Control	Thermostatic
Plumbing System Compatibility	Low and high pressure
Inlet Connections	15mm compression
Water Entry Points	Rising, falling, back
Outlet Connection	1/2" BSP top or bottom
Minimum Running Pressure/Flow	0.1Bar @ 8l/min
Maximum Running Pressure	5 Bar
Open Outlet Flow Rate at 0.1Bar	7l/min
Maximum Flow with Flow Limiters Fitted	12l/min
Approvals, Complies with	WRAS, TMV3
TMV3 Designation	HP-5
Guarantee	5 years

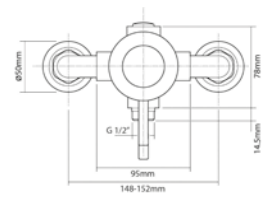

Finish	Code
Chrome	ELICMINCEXVO*
Chrome	ELICMINCEX

*Valve only

Elina Inclusive TMV3 Concentric Built-in Mixer

thermostatic mixer shower

Temperature Control	Thermostatic
Plumbing System Compatibility	Low and high pressure
Inlet Connections	15mm compression
Water Entry Points	Rising, falling, back
Outlet Connection	1/2" BSP top or bottom
Minimum Running Pressure/Flow	0.1Bar @ 8l/min
Maximum Running Pressure	5 Bar
Open Outlet Flow Rate at 0.1Bar	7l/min
Maximum Flow with Flow Limiters Fitted	12l/min
Approvals, Complies with	WRAS, TMV3
TMV3 Designation	HP-5
Built-In depth (Built-In only)	55mm minimum
Guarantee	5 years

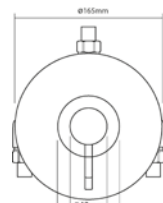

Finish	Code
Chrome	ELICMINCBTVO*
Chrome	ELICMINCBT

*Valve only

Elina Inclusive TMV3 Sequential Built-in Mixer

thermostatic mixer shower

Temperature Control	Thermostatic
Plumbing System Compatibility	Low and High pressure
Inlet Connections	15mm compression to flat face union
Water Entry Points	Rising, falling, back
Outlet Connection	1/2" BSP top or bottom
Minimum Running Pressure/Flow	0.1Bar @ 8l/min
Maximum Running Pressure	5 Bar
Maximum Static Pressure	10 Bar
Open Outlet Flow Rate at 0.1Bar	6l/min
Maximum Flow with Flow Limiters Fitted	12l/min
Pipe Inlet Centres	150mm
Approvals, Complies with	WRAS, TMV3
Built-In depth (Built-In only)	55mm minimum
Guarantee	5 years

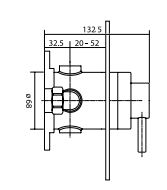
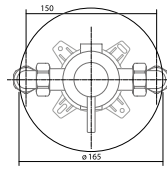

Finish	Code
Chrome	ELITMV3BTSL

Elina inclusive TMV3 Bar Mixer

Temperature Control	Thermostatic
Plumbing System Compatibility	Low and High pressure
Inlet Connections	15mm push fit
Outlet Connection	1/2" BSP bottom
Minimum Running Pressure/Flow	0.1Bar @ 8l/min
Maximum Running Pressure	5 Bar
Maximum Static Pressure	10 Bar
Open Outlet Flow Rate at 0.1Bar	3.5l/min
Maximum Flow with Flow Limiters Fitted	12l/min
Pipe Inlet Centres	150mm
Approvals, Complies with	TMV3, WRAS
Guarantee	5 years

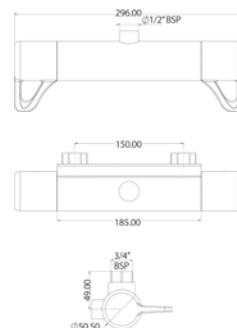

Finish	Code
Chrome	ELITHBMINC3
Chrome	ELITHBMINC3BOT*

*With grab kit

T30i

hand wash unit

Temperature Control	Stabilised
Power Ratings	3kW (at 240)
Inlet Connection	15mm compression
Water Entry Points	Right: bottom
Cable Entry Points	Right: bottom, middle back, top
Outlet Connection	1/2" BSP
Plumbing System	Cold water only
Minimum Running Pressure/Flow	1 Bar @ 8 l/min
Maximum Static Pressure	10 Bar
Surface Mounted Only	
IP Rating	IPX4
Approvals, Complies with	BEAB, CE
Guarantee	1 year

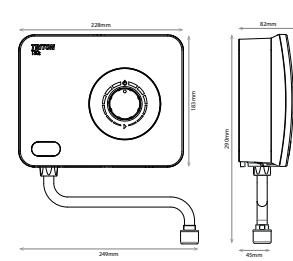

Finish	Power	Code
White	3kW	XTSPT303I

Elina Inclusive TMV3 Sequential Exposed Mixer

thermostatic mixer shower

Temperature Control	Thermostatic
Plumbing System Compatibility	Low and High pressure
Inlet Connections	15mm compression to flat face union
Water Entry Points	Rising, falling, back
Outlet Connection	1/2" BSP top or bottom
Minimum Running Pressure/Flow	0.1Bar @ 8l/min
Maximum Running Pressure	5 Bar
Maximum Static Pressure	10 Bar
Open Outlet Flow Rate at 0.1Bar	6l/min
Maximum Flow with Flow Limiters Fitted	12l/min
Pipe Inlet Centres	150mm
Approvals, Complies with	WRAS, TMV3
Built-In depth (Built-In only)	55mm minimum
Guarantee	5 years

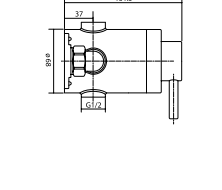
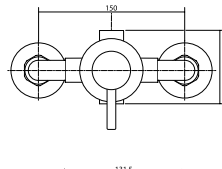

Finish	Code
Chrome	ELITMV3EXSL

NovelSR Power Shower

thermostatic power shower

Temperature Control	Thermostatic
Voltage 230/240v Ac.	Rating 150W nominal
Plumbing System Compatibility	Low pressure gravity
Inlet Connections	15mm push fit
Water Entry Points	Rising, falling, back
Outlet Connection	1/2" BSP
Minimum Head Pressure	75mm
Maximum Head Pressure	10m
Maximum Open Outlet Flow Rate	14l/min
Approvals, Complies with	BEAB, CE, BSI Kitemark
Guarantee	1 year

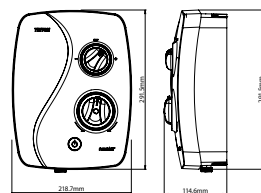

Finish	Code
White	XIPSTHMSRI

T30iR

hand wash unit

Temperature Control	Stabilised
Power Ratings	3kW (at 240)
Inlet Connection	15mm compression
Water Entry Points	Right: bottom
Cable Entry Points	Right: bottom, middle back, top
Outlet Connection	1/2" BSP
Plumbing System	Cold water only
Minimum Running Pressure/Flow	1 Bar @ 8 l/min
Maximum Static Pressure	10 Bar
Surface Mounted Only	
IP Rating	IPX4
Approvals, Complies with	BEAB, CE
Guarantee	1 year

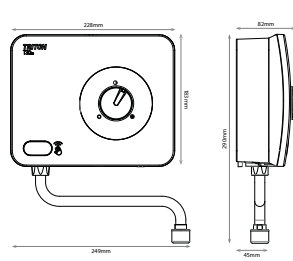

Finish	Power	Code
White	3kW	XTSPT303IR

Instaflow

single point water heater

Power Ratings	5.4kW (at 240V)
Finish	White
Visual Indicators	Power-On
Water Connection	1/2" BSP
Terminal Block	5.4kW 6mm Max Cable
Water Supply	Mains Cold Water
Water Pressure Min	0.4 bar
Water Pressure Max	6 bar
Activation Point	2l/min
Power Setting	Variable - Temperature Determined By Flow And Incoming Water Temp

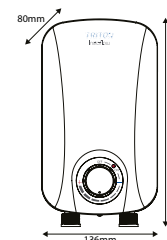

Finish	Power	Code
White	5.4kW	SPINSFOSSW

Instaflow

multi point water heater

Power Ratings	7.7kW & 10.1kW (at 240V)
Finish	White
Visual Indicators	Power-On
Water Connection	1/2" BSP
Terminal Block	10mm Max Cable
Water Supply	Mains Cold Water
Water Pressure Min	0.6 bar
Water Pressure Max	6 bar
Activation Point	2.7l/min
Power Setting	Variable - Temperature Determined By Flow And Incoming Water Temp

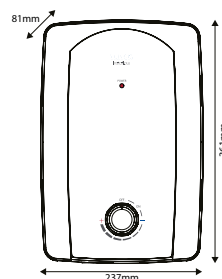

Finish	Power	Code
White	7.7kW	SPINSF07MW
White	10.1kW	SPINSF10MW

Shower specifications

Instaflow

stored water heater

Capacity	5L, 10L, 15L
Power ratings	1.5kW (230V) - 5L 2.0kW (230V) - 10L & 15L
Energy Rating	B
Installation	Wall hung - brackets supplied Dielectric Connectors Pressure Relief Device
Electrical Connection	10A Plug Socket
Temperature Control	Thermostatic
Max Temperature	75°C
Min Pressure	0.5bar
Max Pressure	6 bar
Water Connection	1/2" BSP

5 Litre

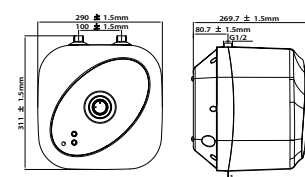

10 Litre

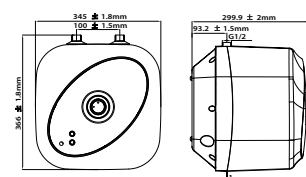

15 Litre

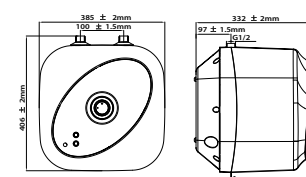

Litres	Power	Code
5L	1.5kW	SPINSF5005
10L	2kW	SPINSF1005
15L	2kW	SPINSF1505

Electric Requirements

CIRCUIT PROTECTION			
Power rating @ 240V	Power rating @ 230V	MCB protection rating	Cartridge Fuse
7.5kW	6.9kW	32A	35A
8.5kW	7.9kW	40A	45A
9.5kW	8.8kW	40/45A	45A
10.5kW	9.6kW	45A	45A

Note: Please note all kW stated throughout the guide are at 240V.

Twin and earth PVC Insulated cable Current carrying capacity		
Installed in an insulated wall	In conduit trunking	Clipped direct or buried in a non-insulated wall
6mm ² = 32A	6mm ² = 32A	6mm ² = 46A
10mm ² = 43A	10mm ² = 52A	10mm ² = 63A
16mm ² = 57A	16mm ² = 69A	16mm ² = 85A

Note: Cable selection is dependent on derating factors
*10 mm² cable must be used on all 10.5kW rated chrome showers

Instantaneous electric shower performance

Temperature/flow rate

Note: The approximate temperatures indicated are based on 0°C ambient incoming water temperature. This can vary between 3°C and 23°C depending on weather conditions.

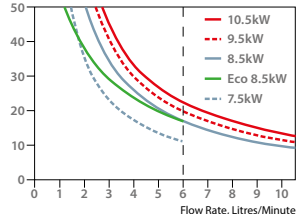

Typical Suitable Installations – Electric showers

Fig 1. Electric Shower Mains Fed Installation

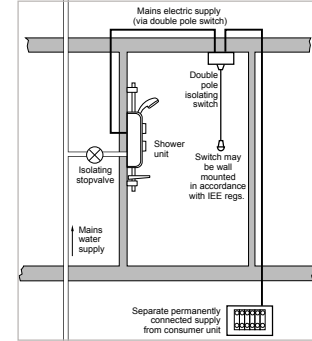

Suitable for the following systems.
For product compatibility, look for the Cold Mains icon as shown.

Fig 2. Digital Electric Shower Installation

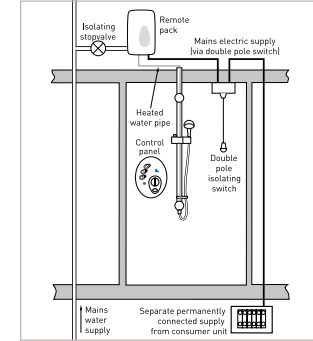

Suitable for the following systems.
For product compatibility, look for the Cold Mains icon as shown.

Typical Suitable Installations – Pumped showers (cistern fed cold only)

Fig 3. Pumped Electric Installation

Suitable for the following systems.

For product compatibility, look for the Low Pressure icon as shown.

WARNING! Under no circumstances must the pumped electric shower be connected directly to the mains water supply.

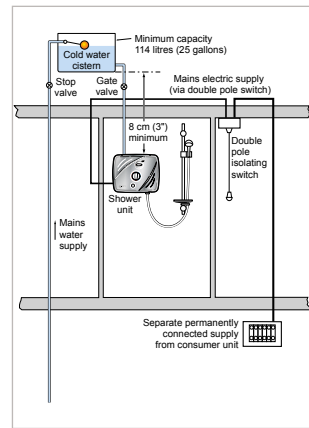

Fig 4. Electric with a Pump Installation

WARNING! Under no circumstances must the T450i pump be connected directly to Satellites HP and LP Mixing Units, Safeguard+, T150Z, Aspirante Power Shower, AS2000XT, AS2000X.

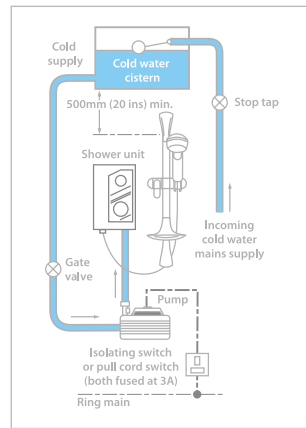
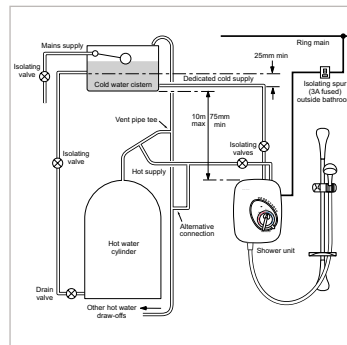

Fig 5. Pumped Power Shower Installation (Gravity Fed System)

Suitable for the following systems.

For product compatibility, look for the Low Pressure icon as shown.



Typical Suitable Installations – High Pressure Digital Mixers

Fig 6. Digital Mixer Installation (Instantaneous Gas Heated Systems e.g. Combination Boilers)

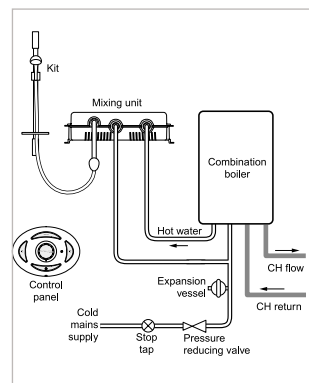

Fig 7. Digital Mixer Installation (Unvented Mains Pressure System)

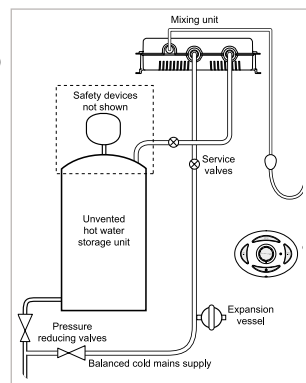
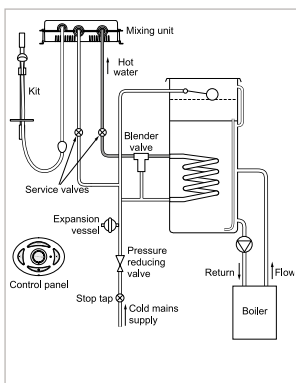

Fig 8. Digital Mixer Installation (Mains Pressurised Thermal Store Systems)

Suitable for the following systems.

For product compatibility, look for the High Pressure icon as shown.



Typical Suitable Installations – Low Pressure Mixer showers

Fig 9. Conventional Low Pressure Mixer Installation (Gravity Fed System)

Suitable for the following systems.

For product compatibility, look for the Low Pressure and All Systems Pressure icons as shown.

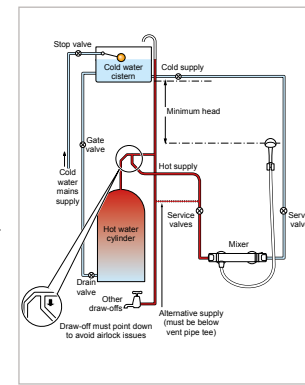

Fig 10. Low Pressure Mixer with a Pump Installation (Gravity Fed System)

Suitable for the following systems.

For product compatibility, look for the Low Pressure icon as shown.

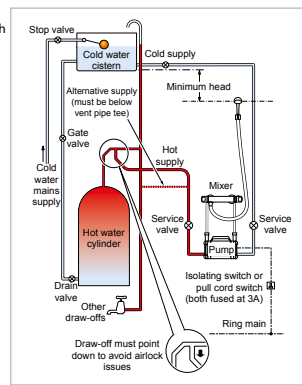
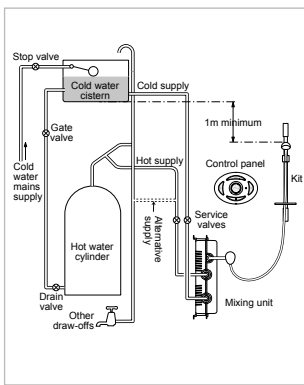

Fig 11. Low Pressure Digital Mixer Installation (Gravity Fed System)

Suitable for the following systems.

For product compatibility, look for the Low Pressure icon as shown.



Typical Suitable Installations – High Pressure Mixer showers

Fig 12. Conventional High Pressure Mixer Installation (Instantaneous Gas Heated System e.g. Combination Boilers)

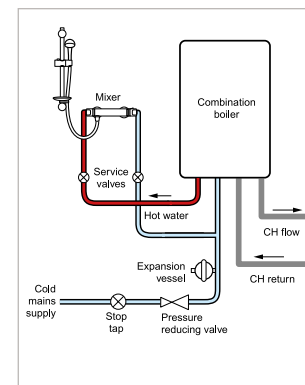

Fig 13. Conventional High Pressure Mixer Installation (Unvented Mains Pressure System)

Suitable for the following systems.

For product compatibility, look for the High Pressure and All Systems Pressure icons as shown.

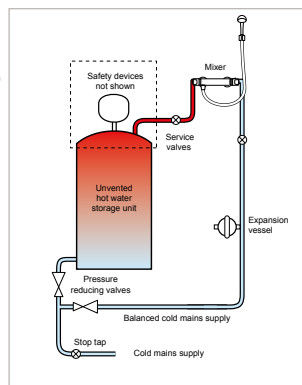
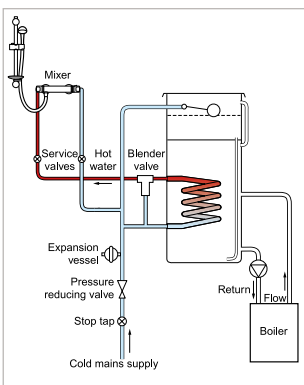

Fig 14. Conventional High Pressure Mixer Installation (Mains Pressurised Thermal Store Systems)

Suitable for the following systems.

For product compatibility, look for the High Pressure and All Systems Pressure icons as shown.





Importer

Earthridge International
Dowdstown
Maynooth
County Kildare

Triton

Triton Road
Nuneaton
Warwickshire
CV11 4NR

Contact:

T (01) 6286711 F (01) 628 6509

Installer Hotline:

+44 (0) 2476 378 320

Customer Service:

T (01) 6286845 or (01) 6286711

Customer Experience:

+44 (0) 2476 372 222

Email:

sales@earthridge.ie

Email:

technical@tritonshowers.co.uk

Website:

www.tritonshowers.ie

Website:

tritonshowers.co.uk



Triton Showers is a division of
Norcross Group (Holdings) Limited.

Triton, Triton Road, Nuneaton,
Warwickshire CV11 4NR

This brochure is printed using Revive 100 uncoated paper which is made from FSC recycled certified post-consumer waste pulp. It is manufactured in accordance with ISO certified standards and is carbon balanced in association with the World Land Trust. Our printer is FSC and ISO 14001 certified and is committed to global carbon reduction.

All dimension illustrations that are featured in this brochure are approximate.

It is our policy to improve the design and specification of our products and we reserve the right to depart from the design given without prior notice. All information in this brochure may be subject to change after the date of printing. E&OE